

SPI

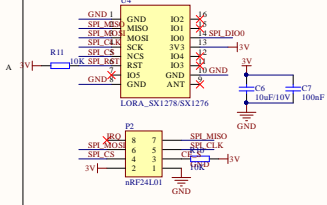

IIC

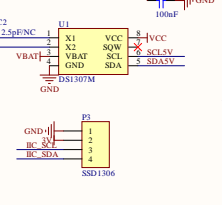

OUTPUT

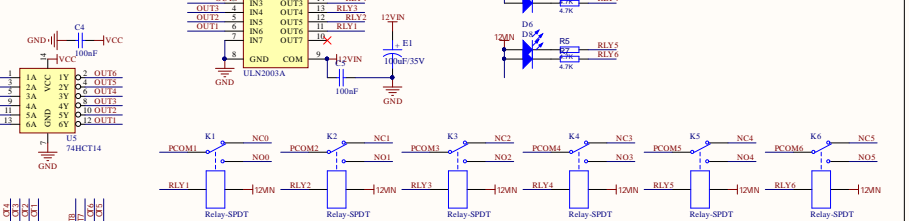

ADC

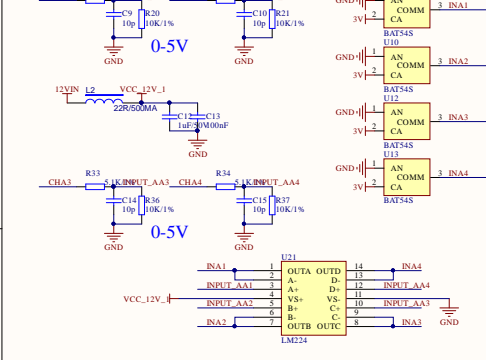

TEM./HUMI.

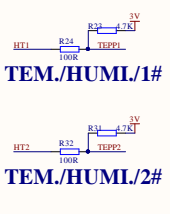

PCF8574

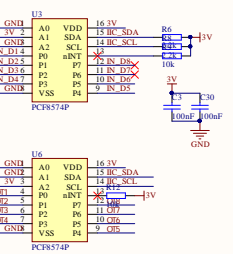

INPUT1

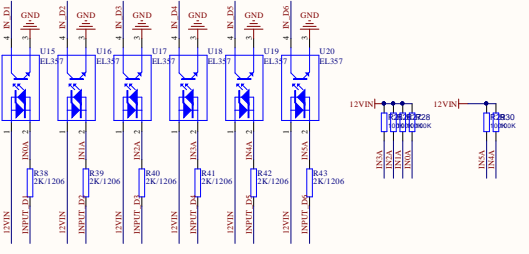

RS232

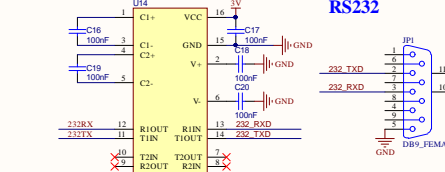

AutoProg

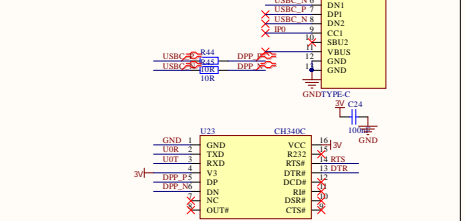

CPU

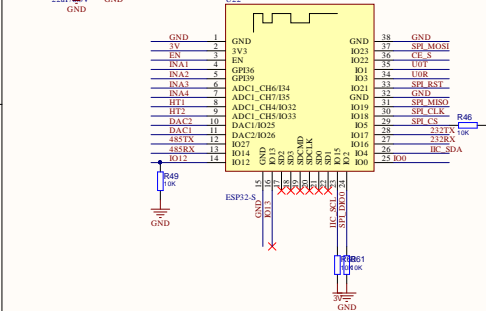

INTERFACE

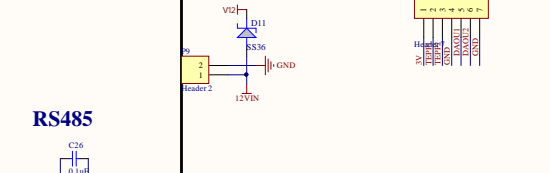

RS485

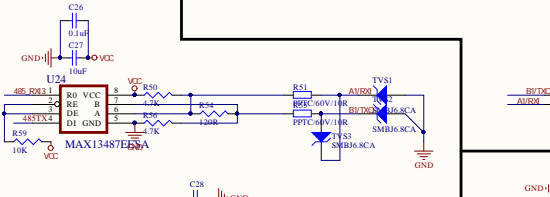

DAC

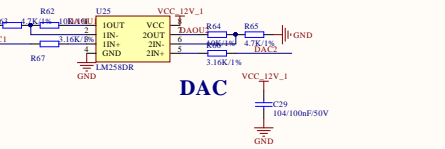

Prog./RST BUTTON

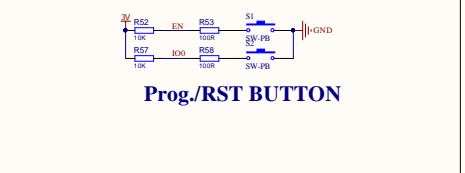

Title		
Size	Number	Revision
A2		
Date:	18.09.2022	Sheet
File:	GLK668-A6-schematic_SchDoc	of
		Drawn By: