

LDO

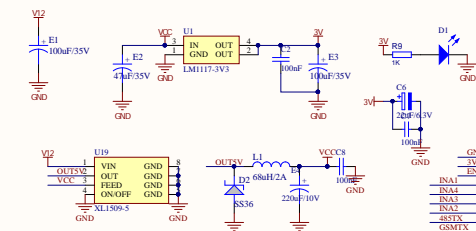

ESP32

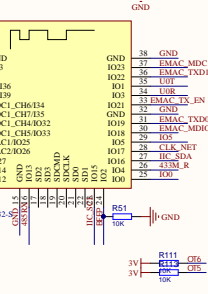

INPUT1

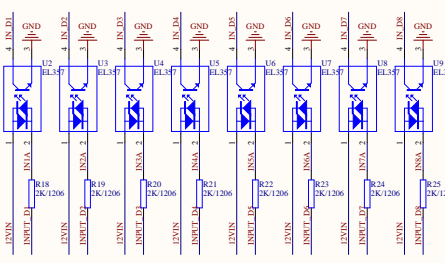

INPUT2

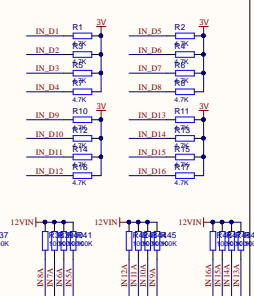
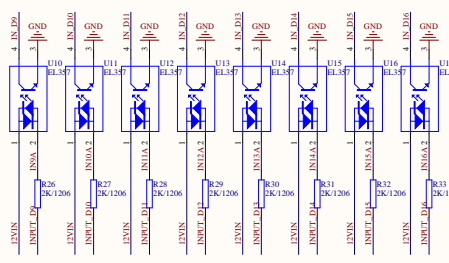

433M RECEIVE

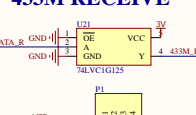

BEEP

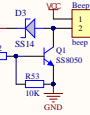

O10

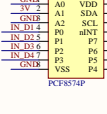

O100

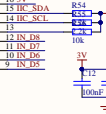

O01

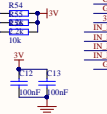

O101

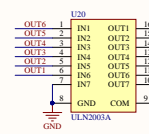
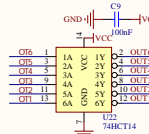
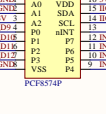

OUTPUT

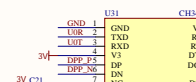
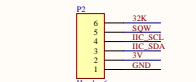
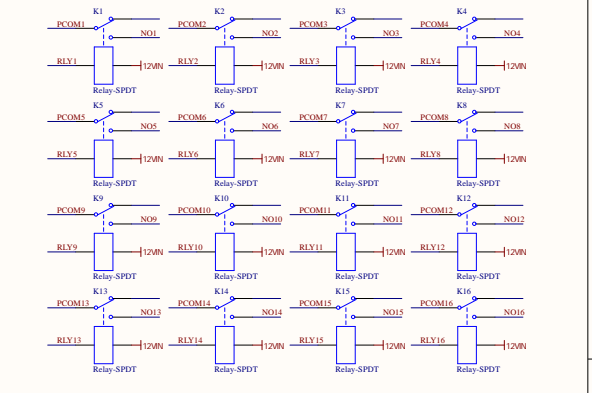

Prog./RST BUTTON

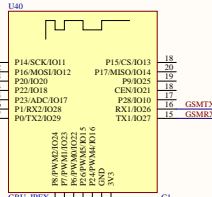
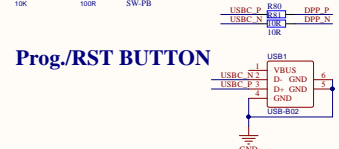

ADC

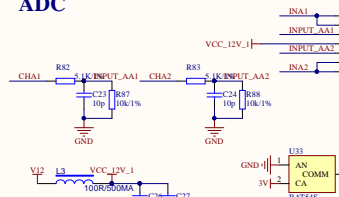

ETHERNET

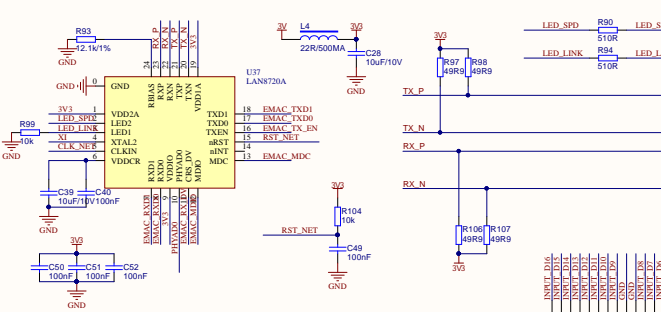

RS485

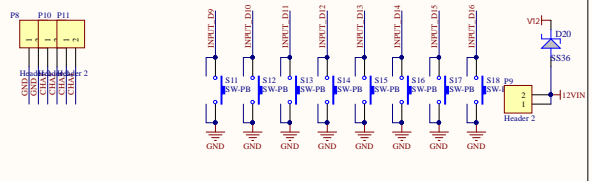
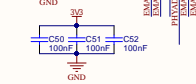
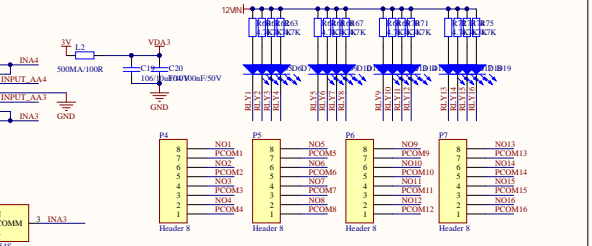
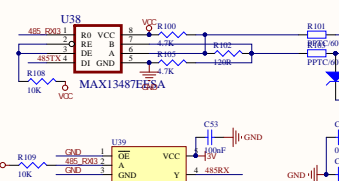

Title	Number	Revision
Size	A4	
Date	2023-03-23	
File	GU-K365-1171-schematic-SciDoc	Sheet 1 of 1
		Printed By: