

# POWER

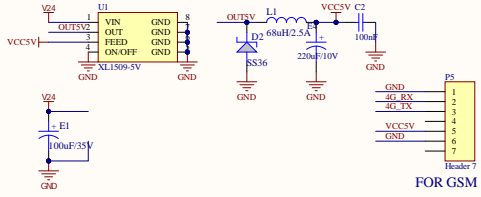

FOR GSM

FOR MAIN

# ESP32

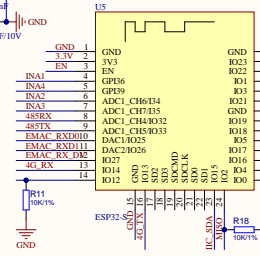

# USB-B

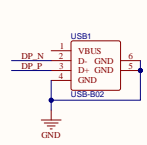

# Auto Prog.

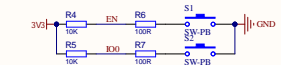

# RS485

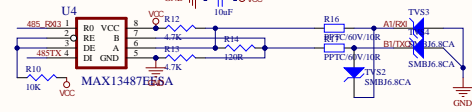

# ETHERNET

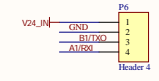
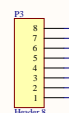
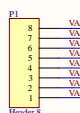
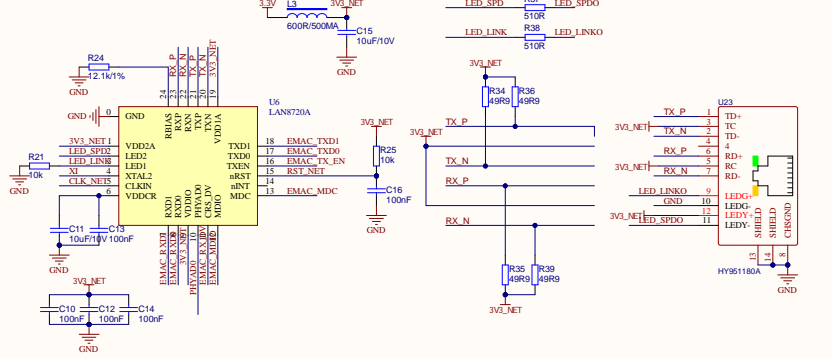

Title	Number	Revision
A2		
Date:	12/11/2023	Sheet of
File:	C:\Users\ADMIN\CONY-MB-V13.SchDoc	Drawn By: